

# Wet Cleaning®

USING WATER  
TO TAKE CARE OF  
DELICATE GARMENTS

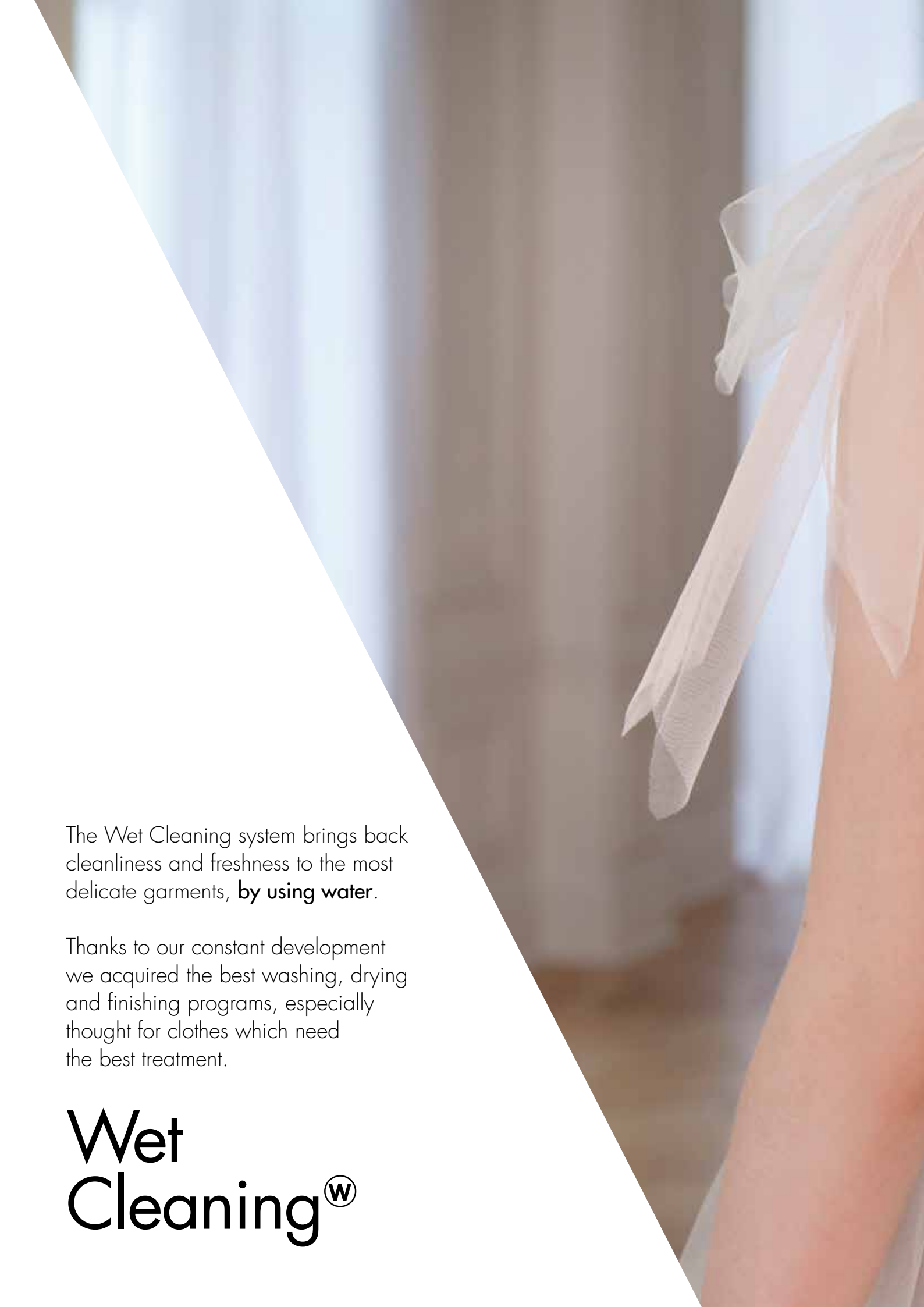



The Wet Cleaning system brings back cleanliness and freshness to the most delicate garments, **by using water.**

Thanks to our constant development we acquired the best washing, drying and finishing programs, especially thought for clothes which need the best treatment.

**Wet  
Cleaning<sup>®</sup>**

Wet Cleaning Process:

**PRE-SPOTTING - WASHING - DRYING - FINISHING**



Professional Wet  
Cleaning



Delicate  
Wet Cleaning



Very delicate  
Wet Cleaning

# Wet Cleaning®

DRY CLEANING



HAND WASHING

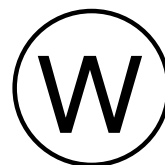
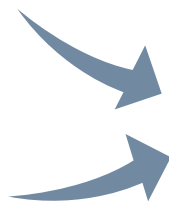

Professional  
Wet Cleaning

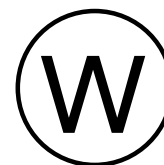

Delicate  
Wet Cleaning

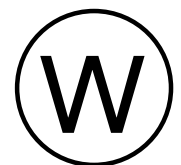

Very delicate  
Wet Cleaning

The optimal and balanced process for professional washing SUCCESS

### Sinner diagram

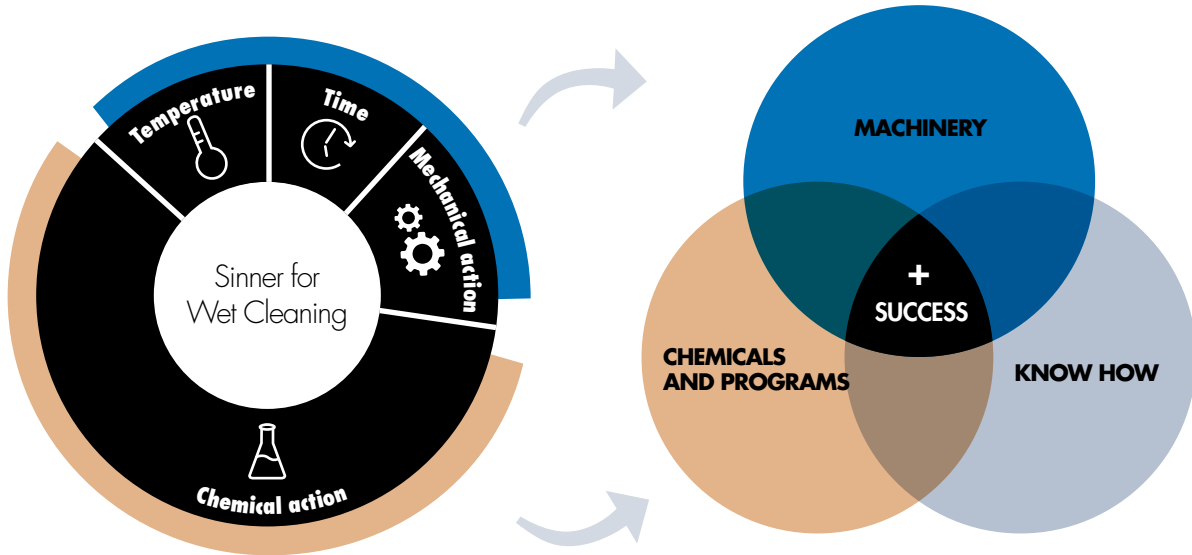

### The best solution for its efficacy

80% 20%

**80% of stains nowadays are soluble in water (Wet Cleaning concept).**

**Only 20% of stains are not soluble in water (Dry Cleaning concept).**

hen...  
Why is the market still using equipment which is only prepared for 20% of stains?

The solution is Wet Cleaning.

All type of garments

TYPE OF STAIN	DRY CLEANING	WET CLEANING
Sweat	2	5
Proteins	1	5
Grease	5	4
Body odors	1	5
Shrinking	3,5	3

DRY vs WET comparison in most common stains.  
1=bad result / 5= excellent result

# Wet Cleaning<sup>W</sup>



PROFESSIONAL KIT

INDUSTRIAL KIT

PLACE	GOAL	DAILY GARMENTS	WASHER MODEL	DANUBE KIT
Small shops	Dry cleaning substitution Wet cleaning beginner	66	WPR-8 ET2	KIT
Small shops	Dry cleaning substitution Additional machinery Wet cleaning beginner	83	WPR-10 ET2	KIT
Small shops	Dry cleaning substitution	129	WED-11 ET2	KIT
Medium size shops New shops	Dry cleaning substitution New shop	168	WED-14 ET2	KIT
Medium size shops (Shopping centre) New shops	Dry cleaning substitution New shop	233	WED-18 ET2	KIT
Large shops (Shopping centre)	Dry cleaning substitution Large shop Big potential, important growth	323	WED-27 ET2	KIT
Laundries Large shops (Shopping centre)	Factories	452	WED-35C ET2	KIT

## Important icons for Wet Cleaning



Filling with stopped drum



Emptying with stopped drum



## TOTAL CONTROL WITH EASY TOUCH 2

Easy programming through icons, with touchscreen directly on the machine or with the computer and Wash Control software.

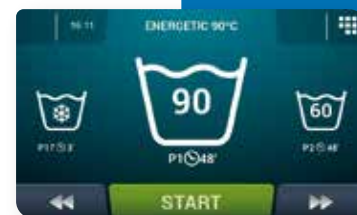

## LIQUID DOSING

Dosing at the right time, with accurate quantity, gives us security during the process and homogeneity in the result. And the most important thing: serenity.

8 dosis signals as standard + 6 extra signals (dosing time, delay, start selection) for all models.

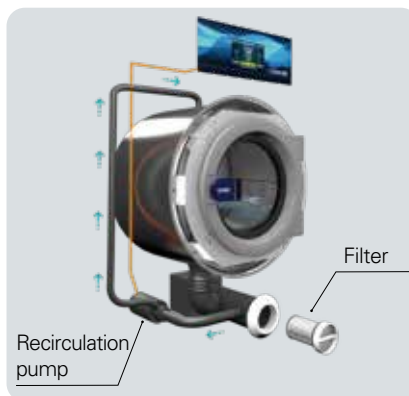

## AQUA-FLOW

Optional kit to increase the care of the linen: recirculation of the bath water, which increases the water flow with chemicals, shortens the cycle and improves the effectiveness without mechanical action.



## WASHING



DRY TO  
IN 1 H



TUBE KIT	KG	DRYER MODEL	CYCLE GARMENTS	DAILY CYCLES	MACHINE FREE FOR OTHER USES	ADVANTAGES
8	5	DPR-8 ET2	7	9	55%	Very low investment Ideal kit for beginners Low operation costs Perfect for small production batches
10	6	DPR-10 ET2	9	9	55%	Very low investment Ideal kit for beginners Low operation costs Ideal for doing only Wet Cleaning
11	6	DD11-GOLD ET2	9	14	30%	Low investment Shops with small Wet Cleaning batches but working long hours Flexibility Compromise flexibility vs production
14	8,5	DD16-GOLD ET2	12	14	30%	Perfect pack for shops (Wet cleaning and normal garments) A good solution for bedspreads, covers and other large garments Versatile
18	11	DD23-GOLD ET2	17	14	30%	Perfect pack for shops (Wet cleaning and normal garments) Productivity Able to wash large covers
27	16,5	DD28-GOLD ET2	23	14	30%	Perfect pack for large shops (Wet cleaning and normal garments) Wet Cleaning productivity Laundry productivity
36	22	DD35-GOLD ET2	32	14	30%	Perfect pack for laundries (Wet cleaning and normal garments) Wet Cleaning productivity Laundry productivity



## DRYING



### TEMPERATURE CONTROL

Temperature and air-flow control result in the perfect drying for delicate garments. The humidity sensor helps to shorten the drying process, thus ensuring an appropriate humidity level for the subsequent ironing of garments.



TO DRY  
HOUR

Temperature sensor IN

Temperature sensor OUT

Humidity sensor

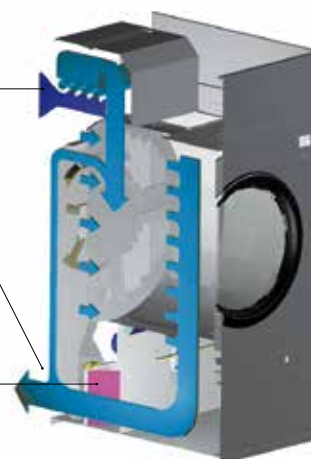

## HOTEL INDUSTRY UNIFORMS



## CARE HOMES



Wet  
Cleaning®

## DRY CLEANER'S

### Application fields

For more information please check our brochures or datasheets, available on our website.

[www.danube-international.com](http://www.danube-international.com)





## Professional and industrial washers

DANUBE heavy professional and industrial washers with new EASY TOUCH 2 microprocessor (and software) offer a user-friendly and ideal programming for Wet Cleaning system.

All models, from 8 to 120kg, are equipped with outstanding features like drum and tub in stainless steel, Hot & Cold Mix (automatic water mixing), Efficient Drum to improve the mechanical action, etc.



WPR-8/10



WED-14

## Professional and industrial dryers

DANUBE heavy professional and industrial dryers with new EASY TOUCH 2 microprocessor offer a variety of ranges and capacities from 8 to 80kg.

The GOLD range is equipped with ideal features to ensure the best results: Air Re-cycle (air recovery), with an intelligent humidity sensor, panels and air circuit with thermal insulation, stainless steel drum, reversing drum, Soft Dry: stamped holes in the drum to take care of delicate garments.



DPR-8/10



DD-16

## STACK The professional duo

The easiest and most economical way to get started in the Wet Cleaning process. STACK is the most accessible solution of Wet Cleaning for 8 and 10 kg machines, that is to say, 4.5 and 6 kg of delicate garments.

As well as industrial machines, STACK includes easy programming EASY TOUCH 2 control to obtain a better functionality and performance.



WPR-8 + DPR-8 STACK

## AQUABAC Water recovery tanks

Perfect system to recover water and chemicals from the different phases. Chemicals can be premixed with water before its use.





Wet  
Cleaning®

**Solutions for finishes**

# Ironed / Restructured

## VACUUM, UP-STEAMING AND BLOWING IRONING TABLES

Available either with built-in electric steam boiler and vacuum unit, or to be connected to an external steam and vacuum supply. It can be supplied in the following versions:

TFC-AVS: with built-in steam boiler of 7 litres-capacity, with standard board (1200 x 400 x 250 mm).

TF-AVS: without boiler, with standard ironing board (1200 x 400 x 250 mm).



TFC-AVS

# Finishers

Automatic "tensioning" finisher for classic coats, overcoats and similar garments.

Working cycle by etr card with 9 stored finishing programs very easy to modify.

Telescopic shape till 1.500 mm, special 350° revolving "body" form plus automatic "front & rear" paddle clamps, double "antistretching" system in large (waist) and in height (length), mechanical adjustable shoulder group and dedicated "collar" clamp, damper for air-volume regulation.

- For central steam & compressed air supply line.
- Can be installed with steam generator GV-24 - 22 kw + recovery tank 83 l



MFV

# Topper

Finishing topper for trousers with air-operated waistband and leg stretching device, for central steam or with automatic electric boiler. To be connected to compressed air.

Side waistband stretching device. Height adjustable leg stretching carriage and stainless steel leg clamps. Built-in three-phase fan; air heating device. Electronic card for the setting of nine ironing cycles in total. Ironing cycle controlling: steaming time, steam/air time, drying time. Three pressure regulators (for leg clamps, waistband stretcher and leg stretching carriage). Switch for the exclusion of the leg stretching carriage. Manual size indicator. Mechanical airflow regulator.



MFP

Wet  
Cleaning®

 **DANUBE**



<https://www.danube-romania.ro>  
office@danube-romania.ro



**ONNERA** GROUP